

TB 9-6625-2346-35

DEPARTMENT OF THE ARMY TECHNICAL BULLETIN

CALIBRATION PROCEDURE FOR OSCILLOSCOPE TEKTRONIX, MODELS 2236, 2236 OPT 14 AND 2236A

Headquarters, Department of the Army, Washington, DC

12 September 2003

Distribution Statement A: Approved for public release; distribution is unlimited

REPORTING OF ERRORS AND RECOMMENDING IMPROVEMENTS

You can improve this manual. If you find any mistakes or if you know of a way to improve these procedures, please let us know. Mail your letter or DA Form 2028 (Recommended Changes to Publications and Blank Forms) directly to: Commander, U.S. Army Aviation and Missile Command, ATTN: AMSAM-MMC-MA-NP, Redstone Arsenal, AL 35898-5000. A reply will be furnished to you. You may also provide DA Form 2028 information to AMCOM via e-mail, fax, or the World Wide Web. Our fax number is DSN 788-6546 or Commercial 256-842-6546. Our e-mail address is: 2028@redstone.army.mil. Instructions for sending an electronic 2028 may be found at the back of this manual. For the World Wide Web, use <https://amcom2028.redstone.army.mil>.

SECTION		Paragraph	Page
I.	IDENTIFICATION AND DESCRIPTION		
	Test instrument identification	1	2
	Forms, records, and reports	2	2
II.	EQUIPMENT REQUIREMENTS		
	Calibration description	3	2
	Equipment required.....	4	4
III.	Accessories required	5	4
	CALIBRATION PROCESS		
	Preliminary instructions	6	5
	Equipment setup.....	7	5
	Vertical.....	8	6
	Horizontal.....	9	15
	Triggering.....	10	21
	Counter timer multimeter.....	11	29
	Probe adjust.....	12	36
	Power supply	13	36
Final procedure	14	37	

SECTION I IDENTIFICATION AND DESCRIPTION

1. Test Instrument Identification. This bulletin provides instructions for the calibration of Oscilloscope Tektronix, Models 2236, 2236 Opt 14 and 2236A. The manufacturers' manuals were used as the prime data sources in compiling these instructions. The equipment being calibrated will be referred to as the TI (test instrument) throughout this bulletin.

a. Model Variations. Variations among models are listed in text.

b. Time and Technique. The time required for this calibration is approximately 4 hours, using the dc and low frequency technique.

2. Forms, Records, and Reports

a. Forms, records, and reports required for calibration personnel at all levels are prescribed by TB 750-25.

b. Adjustments to be reported are designated (R) at the end of the sentence in which they appear. When adjustments are in tables, the (R) follows the designated adjustment. Report only those adjustments made and designated with (R).

3. Calibration Description. TI parameters and performance specifications which pertain to this calibration are listed in table 1.

Table 1. Calibration Description

Test instrument parameters	Performance specifications
Vertical Deflection	Range: 2 mV/div to 5 V/div Accuracy: ±2%
Bandwidth	Range: 2 mV/div Accuracy: Dc to at least 90 MHz Range: 5 mV/div to 5 V/div Accuracy: Dc to at least 100 MHz
Aberrations (2236, 2236 opt 14)	Range: 2 mV/div Accuracy: +5%, -5%, 5% p-p Range: 5 mV/div to 0.5 V/div Accuracy: +4%, -4%, 4% p-p

Table 1. Calibration Description - Continued

Test instrument parameters	Performance specifications			
Aberrations (2236A) Horizontal A sweep timing B sweep timing Sweep linearity Deflection (X-Axis)	Range: 2 mV/div to 0.5 V/div Accuracy: +4%, -4%, 4% p-p Range: 0.5 s/div to 0.05 μs/div Accuracy: ±2% Range: (X10 mag): 50 ms/div to 5 ns/div Accuracy: ±3% Range: 50 ms/div to 0.05 μs/div Accuracy: ±2% Range: (X10 mag): 5 ms/div to 5 ns/div Accuracy: ±3% Accuracy: ±5% (measured over any 2 of the center 8 divisions) Range: 2 mV/div to 5 V/div Accuracy: ±3%			
A trigger sensitivity	Frequency	10 MHz	60 MHz	100 MHz
	Internal	0.35 div	1.2 div	1.5 div
	External	40 mV	150 mV	250 mV
B trigger sensitivity	Internal only	0.35 div	1.2 div	1.5 div
Probe adjust	Range: 0.5 V p-p Accuracy: ±5%			
Counter timer multimeter Time base DC Volts AC Volts Resistance	Accuracy: ±1 X 10 ⁻⁵ ; ±1 X 10 ⁻⁷ (2236 opt 14) Range: 0.5 to 500 V Accuracy: ±0.1% of rdg + 1 LSD Range: 0.5 to 350 V Accuracy: ±1% of rdg + 6 LSD Range: Accuracy: 50 Ω ± 0.3% of rdg + 20 LSD 500 Ω ± 0.15% of rdg + 2 LSD 5 kΩ ± 0.15% of rdg + 2 LSD 50 kΩ ± 0.15% of rdg + 2 LSD 500 kΩ ± 0.15% of rdg + 2 LSD 5 MΩ ± 0.15% of rdg + 2 LSD 50 MΩ ± 0.15% of rdg + 2 LSD 100 MΩ ± 1% of rdg + 1 LSD			
CH 1 Volts DC Volts AC Volts	Range: 0.5 to 500 V Accuracy: ±0.3% of rdg + 6 LSD Range: 0.5 to 350 V @ 20 kHz Accuracy: ±1% of rdg + 6 LSD			

SECTION II EQUIPMENT REQUIREMENTS

4. Equipment Required. Table 2 identifies the specific equipment to be used in this calibration procedure. This equipment is issued with Secondary Transfer Calibration Standards Set AN/GSM-286, AN/GSM-287, or AN/GSM-705. Alternate items may be used by the calibrating activity. The items selected must be verified to perform satisfactorily prior to use and must bear evidence of current calibration. The equipment must meet or exceed the minimum use specifications listed in table 2. The accuracies listed in table 2 provide a four-to-one ratio between the standard and TI. Where the four-to-one ratio cannot be met, the four-to-one accuracy of the equipment selected is shown in parenthesis.

5. Accessories Required. The accessories required for this calibration are common usage accessories issued as indicated in 4 above, and are not listed in this calibration procedure. The following peculiar accessory is also required for this calibration: standardizer, 5-80 pF.

Table 2. Minimum Specifications of Equipment Required

Common name	Minimum use specifications	Manufacturer and model (part number)
OSCILLOSCOPE CALIBRATOR	Volts out: Range: 10 mV to 20 V Accuracy: ±0.5% Time markers: Range: 5 ns/D to 0.5 s/D Accuracy: ±0.5% Sine wave frequency: Range: 50 kHz to >100 MHz	John Fluke, Model 5820A, MIS-38938 (5820A-5C-GHZ)
CALIBRATOR	DC Volts: Range: 400 mV to 400 V Accuracy: ±0.025% AC Volts: Range: 400 mV to 300 V Accuracy: (20 Hz to 20 kHz) ±0.25% Resistance: Range: 10 Ω to 100 MΩ Accuracy: ±0.0375%	John Fluke, Model 5720A/CT (p/o MIS-35947), w/power amplifier, John Fluke, Model 5725A/CT (5725A/CT)
DIGITAL MULTIMETER	Range: -8.64 to < 0.1 V dc Accuracy: ±0.12%	John Fluke, Model 8840A/AF-05/09 (AN/GSM-64D)
GPS TIME/FREQUENCY GENERATOR	Output Frequency: 1 MHz Accuracy: 1 X 10 ⁻⁸	Datum, Model 9390-6000

SECTION III CALIBRATION PROCESS

6. Preliminary Instructions

a. The instructions outlined in paragraphs 6 and 7 are preparatory to the calibration process. Personnel should become familiar with the entire bulletin before beginning the calibration.

b. Items of equipment used in this procedure are referenced within the text by common name as listed in table 2.

c. Unless otherwise specified, verify the result of each test and, whenever the test requirement is not met, take corrective action before continuing with the calibration. Adjustments required to calibrate the TI are included in this procedure. Additional maintenance information is contained in the manufacturer's manuals for this TI.

d. When indications specified in paragraphs 8 through 12 are not within tolerance, perform the power supply check prior to making adjustments. After adjustments are made, repeat paragraphs 8 through 12. Do not perform power supply check if all other parameters are within tolerance.

e. Unless otherwise specified, all controls and control settings refer to TI.

7. Equipment Setup

WARNING

HIGH VOLTAGE is used or exposed during the performance of this calibration. DEATH ON CONTACT may result if personnel fail to observe safety precautions. REDUCE OUTPUT(S) to minimum after each step within the performance check where applicable.



a. Remove protective cover from TI only when necessary to make adjustments. Replace cover after completing the adjustments.

b. Connect TI to a 115 V ac source.

c. Position TI controls as listed in (1) through (22) below:

- (1) **INTENSITY A** and **B** fully ccw.
- (2) **↑ POSITION** to midrange.
- (3) **↔ POSITION** to midrange.
- (4) **VERTICAL MODE CH 1 BOTH CH 2** to **CH1**.
- (5) **BW LIMIT 20 MHz** pushbutton to out position.
- (6) **CH1** and **CH2 VOLTS/DIV CAL** fully cw to detent.
- (7) **CH2 INVERT** pushbutton to out position.
- (8) **CH1** and **CH2 AC GND DC** switches to **DC**.

TB 9-6625-2346-35

- (9) **HORIZONTAL MODE** switch to **A**.
 - (10) **A AND B SEC/DIV** switches to **.2 ms**.
 - (11) **X10 CAL** fully cw to detent and pushed in.
 - (12) **VAR HOLDOFF** fully ccw to **NORM**.
 - (13) **B TRIGGER SLOPE** pushbutton to **OUT:** 
 - (14) **B TRIGGER LEVEL** fully cw.
 - (15) **A TRIGGER P-P AUTO** pushbutton to in position.
 - (16) **A TRIGGER NORM** to out position.
 - (17) **A TRIGGER SLOPE** pushbutton to **OUT:** 
 - (18) **A TRIGGER LEVEL** to midrange.
 - (19) **A TRIGGER A & B INT** switch to **VERT MODE** (2236).
 - (20) **A TRIGGER A & B SOURCE** switch to **VERT MODE** (2236A).
 - (21) **A TRIGGER A SOURCE** switch to **INT** (2236).
 - (22) **A TRIGGER A COUPL** switch to **NORM** (2236A).
- d. Press **TI POWER** pushbutton to **ON** and allow at least 20 minutes for warm-up.
- e. Adjust **A INTENSITY** and **FOCUS** controls for suitable viewing.

8. Vertical

a. Performance Check

- (1) Connect oscilloscope calibrator **SOURCE/MEASURE CHAN 1** to **TI CH 1** input and oscilloscope calibrator **SOURCE/MEASURE CHAN 2** to **TI CH 2** input.
- (2) Set **TI CH 1 VOLTS/DIV** switch to **2m**.
- (3) Set oscilloscope calibrator **CH 1** for a **VOLTAGE** output of 10 mV at 1 kHz.
- (4) Adjust **TI A TRIGGER LEVEL** and **POSITION** controls, as necessary, to view waveform.
- (5) Rotate oscilloscope calibrator knob located below **EDIT FIELD** key for 5 divisions of vertical display. If oscilloscope calibrator **Err** display does not indicate within limits specified in first row of table 3, perform **b** (1) through (41) below.
- (6) Repeat technique of (2) through (5) above for settings listed in table 3. If oscilloscope calibrator **Err** display does not indicate within limits specified in table 3, perform **b** (1) through (41) below.

Table 3. CH 1 Vertical Deflection

Test instrument		Oscilloscope calibrator	
VOLTS/DIV setting	Divisions of vertical deflection	VOLTAGE output	Err display Indication (%)
2 m	5	10 mV	± 2
5 m	4	20 mV	± 2
10 m	5	50 mV	± 2
20 m	5	.1 V	± 2
50 m	4	.2 V	± 2
.1	5	.5 V	± 2
.2	5	1 V	± 2
.5	4	2 V	± 2
1	5	5 V	± 2
2	5	10 V	± 2
5	4	20 V	± 2

- (7) Set oscilloscope calibrator output to standby.
- (8) Set TI **CH 2 VOLTS/DIV** switch to **2m**.
- (9) Set oscilloscope calibrator **CH 2** for a **VOLTAGE** output of 10 mV at 1 kHz.
- (10) Adjust TI **A TRIGGER LEVEL** and **POSITION** controls as necessary to view waveform.
- (11) Rotate oscilloscope calibrator knob located below **EDIT FIELD** key for 5 divisions of vertical display. If oscilloscope calibrator **Err** display does not indicate within limits specified in first row of table 4, perform **b** (41) through (82) below.
- (12) Repeat technique of (8) through (11) above for settings listed in table 4. If oscilloscope calibrator **Err** display does not indicate within limits specified in table 4, perform **b** (41) through (82) below.

Table 4. CH 2 Vertical Deflection

Test instrument		Oscilloscope calibrator	
VOLTS/DIV setting	Divisions of vertical deflection	VOLTAGE output	Err display Indication (%)
2 m	5	10 mV	± 2
5 m	4	20 mV	± 2
10 m	5	50 mV	± 2
20 m	5	.1 V	± 2
50 m	4	.2 V	± 2
.1	5	.5 V	± 2
.2	5	1 V	± 2
.5	4	2 V	± 2
1	5	5 V	± 2
2	5	10 V	± 2
5	4	20 V	± 2

- (13) Set oscilloscope calibrator output to standby.
- (14) Connect oscilloscope calibrator **SOURCE/MEASURE CHAN 1** through a 50Ω feed through termination to TI **CH 1** input and oscilloscope calibrator **SOURCE/MEASURE CHAN 2** through a 50Ω feed through termination to TI **CH 2** input.
- (15) Position TI switches as listed in (a) through (c) below:

TB 9-6625-2346-35

- (a) **VERTICAL MODE CH 1 BOTH CH 2 to CH 1.**
- (b) **CH 1 and CH 2 VOLTS/DIV to 2m.**
- (c) **A AND B SEC/DIV to .05 μs.**

(16) Set oscilloscope calibrator for a **CHAN 1, EDGE** mode output of 10 mV at a frequency of 1 MHz.

(17) Adjust TI CH 1 **⇕ POSITION** control to position top of displayed waveform to center horizontal graticule line. If square wave aberrations are not within limits specified in first row of table 5, perform **b** (83) through (91) below.

(18) Repeat technique of (15) (b), (16) and (17) above for settings and outputs listed in table 5. If square wave aberrations are not within limits specified in table 5, perform **b** (83) through (91) below.

Table 5. Channel 1 Vertical Deflection Aberration Limits

Oscilloscope calibrator EDGE mode output		Test instrument		
Amplitude	Frequency	A AND B SEC/DIV (μs)	VOLTS/DIV	Aberration limits (minor divisions)
10 mVpp	1 MHz	0.05	2 mV	< 1
50 mVpp	1 MHz	0.05	10 mV	< 1
100 mVpp	1 MHz	0.05	20 mV	< 1
250 mVpp	1 MHz	0.05	50 mV	< 1
.5 Vpp	1 MHz	0.05	.1 V	< 1
1 Vpp	1 MHz	0.05	.2 V	< 1

(19) Set oscilloscope calibrator output to standby.

(20) Set TI **VERTICAL MODE CH 1 BOTH CH 2** switch to **CH 2**.

(21) Set oscilloscope calibrator for a **CHAN 2, EDGE** mode output of 10 mV at a frequency of 1 MHz.

(22) Adjust TI CH 1 **⇕ POSITION** control to position top of displayed waveform to center horizontal graticule line. If square wave aberrations are not within limits specified in first row of table 6, perform **b** (92) through (100) below.

(23) Repeat technique of (15) (b), (16) and (17) above for settings and outputs listed in table 6. If square wave aberrations are not within limits specified in table 6, perform **b** (92) through (100) below.

Table 6. Channel 2 Vertical Deflection Aberration Limits

Oscilloscope calibrator EDGE mode output		Test instrument		
Amplitude	Frequency	A AND B SEC/DIV (μs)	VOLTS/DIV	Aberration limits (minor divisions)
10 mVpp	1 MHz	0.05	2 mV	< 1
50 mVpp	1 MHz	0.05	10 mV	< 1
100 mVpp	1 MHz	0.05	20 mV	< 1
250 mVpp	1 MHz	0.05	50 mV	< 1
.5 Vpp	1 MHz	0.05	.1 V	< 1
1 Vpp	1 MHz	0.05	.2 V	< 1

(24) Position TI switches as listed in (a) through (c) below:

(a) **VERTICAL MODE CH 1 BOTH CH 2 to CH 1.**

(b) **CH 1 and CH 2 VOLTS/DIV to 2m.**

(c) **A AND B SEC/DIV to 20 μs.**

(25) Set oscilloscope calibrator for a **CHAN 1, LEVEL SINE** mode output of 12 mV at a frequency of 50 kHz.

(26) Rotate oscilloscope calibrator knob below **EDIT FIELD** pushbutton to adjust amplitude for 6 divisions of deflection on TI.

NOTE

To perform step below, press oscilloscope calibrator **EDIT FIELD** pushbutton as required to place underline under one of the frequency digits.

(27) Rotate oscilloscope calibrator knob below **EDIT FIELD** pushbutton to sweep oscilloscope calibrator from 50 kHz to frequency limit specified in first row of table 7 while observing displayed waveform amplitude on TI crt. Displayed waveform amplitude will be within limits specified in first row of table 7 throughout entire frequency range sweep.

(28) Repeat technique of (24) (b) and (25) through (27) above for remaining TI settings and oscilloscope calibrator outputs in table 7. Displayed waveform amplitude will be within limits specified in table 7 throughout entire frequency range sweep.

Table 7. Channel 1 Bandwidth

Oscilloscope calibrator LEVEL SINE mode output		Test instrument		
Amplitude	Frequency sweep	VOLTS/DIV	A AND B SEC/DIV	Amplitude limits (divisions)
12 mV	50 kHz to 90 MHz ¹	2 m	20 μs	≥ 4.2
60 mV	50 kHz to 100 MHz ¹	10 m	20 μs	≥ 4.2
3.0 V	50 kHz to 100 MHz ¹	.5	20 μs	≥ 4.2

¹Press **Set to 50 kHz** blue soft pushbutton to quickly return to 50 kHz.

(29) Set TI **VERTICAL MODE CH 1 BOTH CH 2** switch to **CH 2.**

(30) Ensure TI **CH 2 VOLTS/DIV** switch is set to **2m.**

(31) Set oscilloscope calibrator for a **CHAN 2, LEVEL SINE** mode output of 12 mV at a frequency of 50 kHz.

(32) Rotate oscilloscope calibrator knob below **EDIT FIELD** pushbutton to adjust amplitude for 6 divisions of deflection on TI.

NOTE

To perform step below, press oscilloscope calibrator **EDIT FIELD** pushbutton as required to place underline under one of the frequency digits.

(33) Rotate oscilloscope calibrator knob below **EDIT FIELD** pushbutton to sweep oscilloscope calibrator from 50 kHz to frequency limit specified in first row of table 8 while

TB 9-6625-2346-35

observing displayed waveform amplitude on TI crt. Displayed waveform amplitude will be within limits specified in first row of table 8 throughout entire frequency range sweep.

(34) Repeat technique of (30) through (33) above for remaining TI settings and oscilloscope calibrator outputs in table 8. Displayed waveform amplitude will be within limits specified in table 8 throughout entire frequency range sweep.

Table 8. Channel 2 Bandwidth

Oscilloscope calibrator LEVEL SINE mode output		Test instrument		
Amplitude	Frequency sweep	VOLTS/DIV	A AND B SEC/DIV	Amplitude limits (divisions)
12 mV	50 kHz to 90 MHz ¹	2 m	20 μ s	≥ 4.2
60 mV	50 kHz to 100 MHz ¹	10 m	20 μ s	≥ 4.2
3.0 V	50 kHz to 100 MHz ¹	.5	20 μ s	≥ 4.2

¹Press **Set to 50 kHz** blue soft pushbutton to quickly return to 50 kHz.

b. Adjustments

- (1) Disconnect equipment setup.
- (2) Set **CH 1 AC GND DC** switch to **AC**.
- (3) Set **CH 1 VOLTS/DIV** switch to **50m**.
- (4) Adjust **CH 1 \updownarrow POSITION** control to position trace on center horizontal graticule line.
- (5) Set **CH 1 VOLTS/DIV** switch to **5m**.
- (6) Adjust R10 (fig. 1) to position trace on center horizontal graticule line.
- (7) Repeat (3) through (6) above for minimum trace shift when setting **CH 1 VOLTS/DIV** from **50m** to **5m**.
- (8) Adjust **CH 1 \updownarrow POSITION** control to position trace on center horizontal graticule line.
- (9) Set **CH 1 VOLTS/DIV** switch to **2m**.
- (10) Adjust R33 (fig. 1) to position trace on center horizontal graticule line.
- (11) Set **CH 1 VOLTS/DIV** switch to **5m**.
- (12) Repeat (8) through (11) above for minimum trace shift when setting **CH 1 VOLTS/DIV** from **5m** to **2m**.
- (13) Connect oscilloscope calibrator CHAN 1 to TI CH 1 using a 50 Ω feedthrough termination.
- (14) Position TI switches as listed in (a) through (c) below:
 - (a) **CH 1 VOLTS/DIV** to **10m**.
 - (b) **CH 1 AC GND DC** to **DC**.
 - (c) **A AND B SEC/DIV** to **20 μ s**.

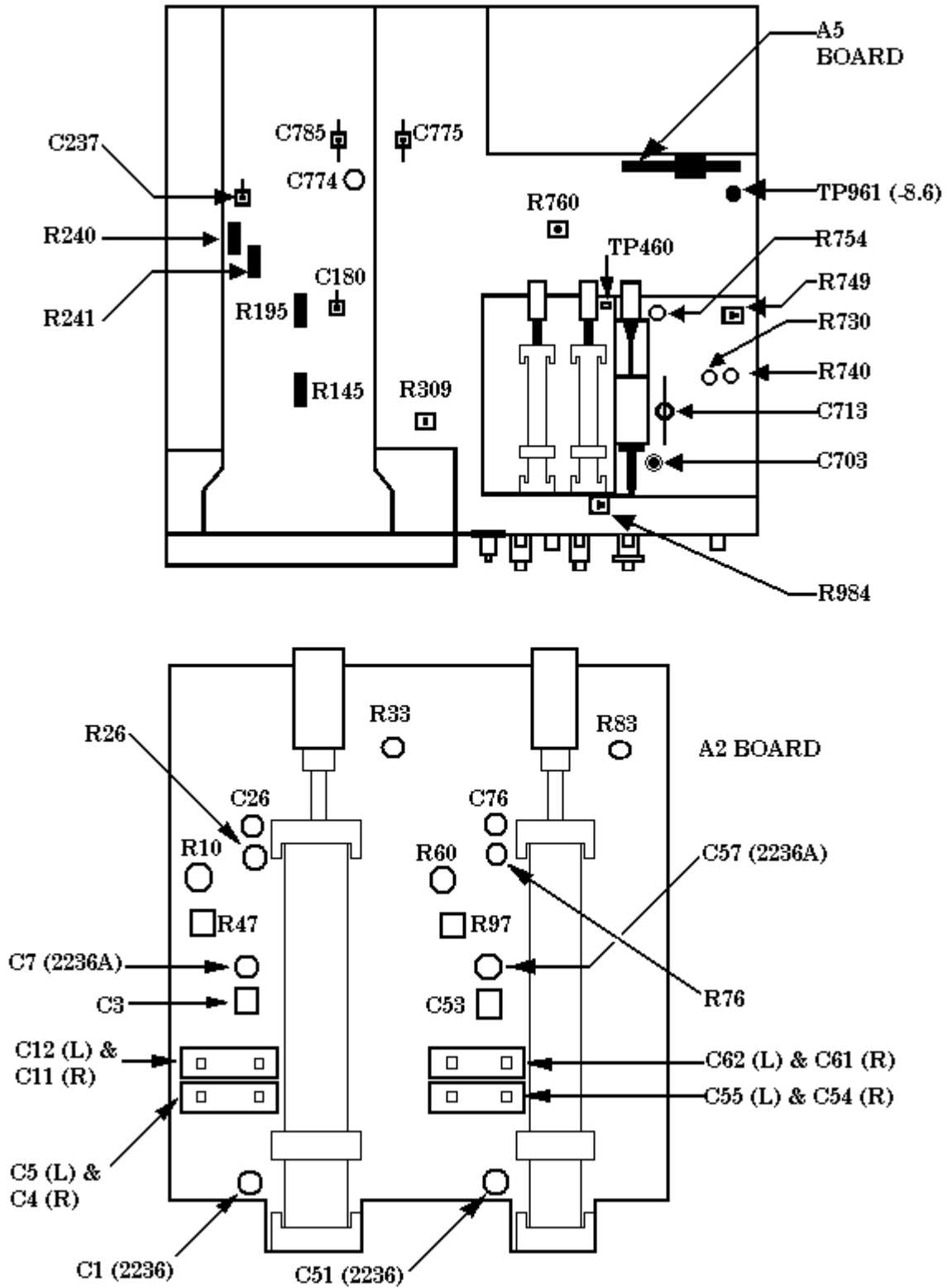

Figure 1. Adjustment locations – top view.

TB 9-6625-2346-35

- (15) Set oscilloscope calibrator for an **EDGE** mode output of 10 kHz and adjust for 5 divisions of vertical deflection on TI.
- (16) Adjust TI **CH 1** **POSITION** control to position top of waveform to center horizontal graticule line.
- (17) Adjust C3 (fig. 1) and R47 (fig. 1) best square corner and flat top.
- (18) Remove 50 Ω feedthrough termination and connect oscilloscope calibrator **CHAN 1** to TI **CH 1**.
- (19) Set oscilloscope calibrator for a **VOLT** mode output of 10 mV at 1 kHz.
- (20) Position TI controls as listed in (a) through (c) below:
 - (a) **CH 1 VOLTS/DIV** switch to **2m**.
 - (b) **A AND B SEC/DIV** switches to **.2 ms**.
 - (c) **CH 1 POSITION** to view waveform.
- (21) Adjust R26 (fig. 1) for 5 divisions of TI vertical deflection (R).
- (22) Set TI **CH 1 VOLTS/DIV** switch to **10m**.
- (23) Set oscilloscope calibrator for a 50 mV output.
- (24) Adjust R145 (fig. 1) for 5 divisions of vertical deflection on TI (R).
- (25) Connect oscilloscope calibrator **CHAN 1** to TI **CH 1** using a 5-80 pF standardizer.
- (26) Set oscilloscope calibrator for an **EDGE** mode output of 1 kHz and adjust for 5 divisions of vertical deflection on TI.
- (27) Adjust 5-80 pF standardizer for optimum square wave.
- (28) Adjust C7 (2236A) (fig. 1) or C1 (2236) (fig. 1) for best flat top.
- (29) Set TI **CH 1 VOLTS/DIV** switch to **.1**.
- (30) Replace 5-80 pF standardizer with 50 Ω feedthrough termination.
- (31) Set oscilloscope calibrator amplitude for 5 divisions of vertical deflection on TI.
- (32) Adjust C12 (fig. 1) for best front corner.
- (33) Replace 50 Ω feedthrough termination with 5-80 pF standardizer and repeat (31) above.
- (34) Adjust C11 (fig. 1) for best flat top.
- (35) Repeat (30) through (34) above until no further improvement is noted.
- (36) Set TI **CH 1 VOLTS/DIV** switch to **1**.
- (37) Remove 5-80 pF standardizer and connect oscilloscope calibrator **CHAN 1** to TI **CH 1**, repeat (31) above.
- (38) Adjust C5 (fig. 1) for best front corner.
- (39) Connect oscilloscope calibrator **CHAN 1** to TI **CH 1** using 5-80 pF standardizer and repeat (31) above.
- (40) Adjust C4 (fig. 1) for best flat top.

- (41) Repeat (37) through (40) above until no further improvement is noted.
- (42) Disconnect oscilloscope calibrator **CHAN 1** from **TI CH 1**.
- (43) Set **CH 2 AC GND DC** switch to **AC**.
- (44) Set **CH 2 VOLTS/DIV** switch to **50m**.
- (45) Adjust **CH 2** \updownarrow **POSITION** control to position trace on center horizontal graticule line.
- (46) Set **CH 2 VOLTS/DIV** switch to **5m**.
- (47) Adjust R60 (fig. 1) to position trace on center horizontal graticule line.
- (48) Repeat (44) through (47) above for minimum trace shift when setting **CH 2 VOLTS/DIV** from **50m** to **5m**.
- (49) Adjust **CH 2** \updownarrow **POSITION** control to position trace on center horizontal graticule line.
- (50) Set **CH 2 VOLTS/DIV** switch to **2m**.
- (51) Adjust R83 (fig. 1) to position trace on center horizontal graticule line.
- (52) Set **CH 2 VOLTS/DIV** switch to **5m**.
- (53) Repeat (49) through (52) above for minimum trace shift when setting **CH 2 VOLTS/DIV** from **5m** to **2m**.
- (54) Connect oscilloscope calibrator **CHAN 1** to **TI CH 2** using a 50 Ω feedthrough termination.
- (55) Position TI switches as listed in (a) through (c) below:
 - (a) **CH 2 VOLTS/DIV** to **10m**.
 - (b) **CH 2 AC GND DC** to **DC**.
 - (c) **A AND B SEC/DIV** to **20 μ s**.
- (56) Set oscilloscope calibrator for an **EDGE** mode output of 10 kHz and adjust for 5 divisions of vertical deflection on TI.
- (57) Adjust **TI CH 2** \updownarrow **POSITION** control to position top of waveform to center horizontal graticule line.
- (58) Adjust C53 (fig. 1) and R97 (fig. 1) best square corner and flat top.
- (59) Remove 50 Ω feedthrough termination and connect oscilloscope calibrator **CHAN 1** to **TI CH 2**.
- (60) Set oscilloscope calibrator for a **VOLT** mode output of 10 mV at 1 kHz.
- (61) Position TI controls as listed in (a) through (c) below:
 - (a) **CH 2 VOLTS/DIV** switch to **2m**.
 - (b) **A AND B SEC/DIV** switches to **.2 ms**.
 - (c) **CH 2** \updownarrow **POSITION** to view waveform.
- (62) Adjust R76 (fig. 1) for 5 divisions of TI vertical deflection (R).
- (63) Set **TI CH 2 VOLTS/DIV** switch to **10m**.
- (64) Set oscilloscope calibrator for a 50 mV output.

TB 9-6625-2346-35

- (65) Adjust R195 (fig. 1) for 5 divisions of vertical deflection on TI (R).
- (66) Connect oscilloscope calibrator **CHAN 1** to TI **CH 2** using a 5-80 pF standardizer.
- (67) Set oscilloscope calibrator for an **EDGE** mode output of 1 kHz and adjust for 5 divisions of vertical deflection on TI.
- (68) Adjust 5-80 pF standardizer for optimum square wave.
- (69) Adjust C57 (2236A) (fig. 1) or C51(2236) (fig. 1) for best flat top.
- (70) Set TI **CH 2 VOLTS/DIV** switch to **.1**.
- (71) Replace 5-80 pF standardizer with 50Ω feedthrough termination.
- (72) Set oscilloscope calibrator amplitude for 5 divisions of vertical deflection on TI.
- (73) Adjust C62 (fig. 1) for best front corner.
- (74) Replace 50Ω feedthrough termination with 5-80 pF standardizer and repeat (31) above.
- (75) Adjust C61 (fig. 1) for best flat top.
- (76) Repeat (71) through (75) above until no further improvement is noted.
- (77) Set TI **CH 2 VOLTS/DIV** switch to **1**.
- (78) Remove 5-80 pF standardizer and connect oscilloscope calibrator **CHAN 1** to TI **CH 2**, repeat (31) above.
- (79) Adjust C55 (fig. 1) for best front corner.
- (80) Connect oscilloscope calibrator **CHAN 1** to TI **CH 2** using 5-80 pF standardizer and repeat (31) above.
- (81) Adjust C54 (fig. 1) for best flat top.
- (82) Repeat (78) through (81) above until no further improvement is noted.
- (83) Position TI switches as listed in (a) through (c) below:
 - (a) **VERTICAL MODE CH 1 BOTH CH 2** to **CH 1**.
 - (b) **CH 1** and **CH 2 VOLTS/DIV** to **10 m**.
 - (c) **A AND B SEC/DIV** to **.05 μs**.
- (84) Connect oscilloscope calibrator **CHAN 1** to TI **CH 1** using a 10X attenuator and a 50Ω feedthrough termination.
- (85) Set oscilloscope calibrator for an **EDGE** mode output of 1 MHz and adjust for 5 divisions of vertical deflection on TI.
- (86) Adjust TI **CH 1** **↑POSITION** control to position top of waveform to center horizontal graticule line.
- (87) Adjust C237 (fig. 1) for minimum overshoot. Adjust R240 (fig. 1) and R241 (fig. 1) for best flat top on front corner of waveform (R).
- (88) Set TI **CH 1 VOLTS/DIV** switch to **2m**.
- (89) Set oscilloscope calibrator output for 5 divisions of vertical deflection on TI.

(90) Adjust TI **CH 1** \updownarrow **POSITION** control to position top of waveform to center horizontal graticule line.

(91) Adjust C26 (fig. 1) for minimum overshoot on waveform (R).

(92) Connect oscilloscope calibrator **CHAN 1** to TI **CH 2** using a 10X attenuator and a 50 Ω feedthrough termination.

(93) Set **VERTICAL MODE CH 1 BOTH CH 2** switch to **CH 2**.

(94) Set oscilloscope calibrator for an **EDGE** mode output of 1 MHz and adjust for 5 divisions of vertical deflection on TI.

(95) Adjust TI **CH 2** \updownarrow **POSITION** control to position top of waveform to center horizontal graticule line.

(96) Adjust C180 (fig. 1) for minimum overshoot on displayed waveform (R).

(97) Set TI **CH 1 VOLTS/DIV** switch to **2m**.

(98) Set oscilloscope calibrator output for 5 divisions of vertical deflection on TI.

(99) Adjust TI **CH 2** \updownarrow **POSITION** control to position top of waveform to center horizontal graticule line.

(100) Adjust C76 (fig. 1) for minimum overshoot on waveform (R).

9. Horizontal

a. Performance Check

(1) Position TI controls as listed in (a) through (f) below:

(a) **VERTICAL MODE CH 1 BOTH CH 2** switch to **CH 1**.

(b) **CH 1 VOLTS/DIV** switch to **.5**.

(c) **A AND B SEC/DIV** to **.05 μ s**.

(d) **B DELAY TIME POSITION** fully ccw.

(e) **B TRIGGER LEVEL** fully cw.

(f) **A TRIGGER NORM** pushbutton pressed.

(2) Connect oscilloscope calibrator **SOURCE/MEASURE CHAN 1** to TI **CH 1** input using 50 Ω a feedthrough termination.

(3) Set oscilloscope calibrator for a **CHAN 1, MARKER** mode output of 50 ns/div.

(4) Adjust TI **A TRIGGER LEVEL**, **A INTENSITY**, and **CH 1** \updownarrow **POSITION** controls for suitable viewing.

(5) Adjust TI \Leftarrow **POSITION** \Rightarrow control to align 2nd time marker with 2nd vertical graticule line.

(6) Rotate oscilloscope calibrator knob located below **EDIT FIELD** pushbutton to align 10th time marker with 10th vertical graticule line. If oscilloscope calibrator **Err** display and TI linearity are not within limits specified in first row of table 9, perform **b** (1) through (10) below.

TB 9-6625-2346-35

(7) Repeat technique of (3) through (6) above for remaining TI settings and oscilloscope calibrator outputs listed in table 9. If oscilloscope calibrator **Err** display and TI linearity are not within limits specified in table 9, perform **b** (1) through (10) below.

Table 9. A Sweep Timing

Oscilloscope calibrator		Test instrument	
MARKER output	Err display limit (%)	A AND B SEC/DIV setting	Linearity over any 2 of center 8 divisions (div)
50 nS/D	± 2	.05 μs	≤ 0.1
.1 μS/D	± 2	.1 μs	≤ 0.1
.2 μS/D	± 2	.2 μs	≤ 0.1
.5 μS/D	± 2	.5 μs	≤ 0.1
1 μS/D	± 2	1 μs	≤ 0.1
2 μS/D	± 2	2 μs	≤ 0.1
5 μS/D	± 2	5 μs	≤ 0.1
10 μS/D	± 2	10 μs	≤ 0.1
20 μS/D	± 2	20 μs	≤ 0.1
50 μS/D	± 2	50 μs	≤ 0.1
.1 mS/D	± 2	.1 ms	≤ 0.1
.2 mS/D	± 2	.2 ms	≤ 0.1
.5 mS/D	± 2	.5 ms	≤ 0.1
1 mS/D	± 2	1 ms	≤ 0.1
2 mS/D	± 2	2 ms	≤ 0.1
5 mS/D	± 2	5 ms	≤ 0.1
10 mS/D	± 2	10 ms	≤ 0.1
20 mS/D	± 2	20 ms	≤ 0.1
50 mS/D	± 2	50 ms	≤ 0.1
.1 S/D	± 2	.1 sec A ONLY	≤ 0.1
.2 S/D	± 2	.2 sec A ONLY	≤ 0.1
.5 S/D	± 2	.5 sec A ONLY	≤ 0.1

(8) Pull TI **A AND B SEC/DIV CAL** knob out for X10 sweep magnification.

(9) Set oscilloscope calibrator for a **CHAN 1, MARKER** mode output of 10 ns/div.

(10) Set TI **A AND B SEC/DIV** to **.05 μs**.

(11) Adjust TI **A TRIGGER LEVEL, A INTENSITY,** and **CH 1 ↕ POSITION** controls for suitable viewing.

(12) Adjust TI **←POSITION⇒** control to align 1st time marker that is 25 ns beyond start of sweep with 2nd vertical graticule line.

(13) Rotate oscilloscope calibrator knob located below **EDIT FIELD** pushbutton to align 5th time marker with 10th vertical graticule line. If oscilloscope calibrator **Err** display and TI linearity are not within limits specified in table 10, perform **b** (11) through (17) below.

Table 10. A Sweep Timing (X10 out)

Oscilloscope calibrator		Test instrument	
MARKER output	Err display limit (%)	A AND B SEC/DIV setting	Linearity over any 2 of center 8 divisions (div)
10 nS/D	± 3	.05 μs	≤ 0.1

(14) Set TI **A AND B SEC/DIV** to **.1 μs**.

(15) Ensure oscilloscope calibrator is set for a **CHAN 1, MARKER** mode output of 10 ns/div.

(16) Adjust TI **A TRIGGER LEVEL, A INTENSITY,** and **CH 1 ↓POSITION** controls for suitable viewing.

(17) Adjust TI **←POSITION⇒** control to align 1st time marker that is 25 ns beyond start of sweep with 2nd vertical graticule line.

(18) Rotate oscilloscope calibrator knob located below **EDIT FIELD** pushbutton to align 10th time marker with 10th vertical graticule line. If oscilloscope calibrator **err** display and TI linearity are not within limits specified in first row table 11, perform **b** (18) through (21) below.

Table 11. A Sweep X10 Timing

Oscilloscope calibrator		Test instrument	
MARKER output	Err display limit (%)	A AND B SEC/DIV setting	Linearity over any 2 of center 8 divisions (div)
10 nS/D	± 3	.1 μs	≤ 0.1
20 nS/D	± 3	.2 μs	≤ 0.1
50 nS/D	± 3	.5 μs	≤ 0.1
.1 μS/D	± 3	1 μs	≤ 0.1
.2 μS/D	± 3	2 μs	≤ 0.1
.5 μS/D	± 3	5 μs	≤ 0.1
1 μS/D	± 3	10 μs	≤ 0.1
2 μS/D	± 3	20 μs	≤ 0.1
5 μS/D	± 3	50 μs	≤ 0.1
10 μS/D	± 3	.1 ms	≤ 0.1
20 μS/D	± 3	.2 ms	≤ 0.1
50 μS/D	± 3	.5 ms	≤ 0.1
.1 mS/D	± 3	1 ms	≤ 0.1
.2 mS/D	± 3	2 ms	≤ 0.1
.5 mS/D	± 3	5 ms	≤ 0.1
1 mS/D	± 3	10 ms	≤ 0.1
2 mS/D	± 3	20 ms	≤ 0.1
5 mS/D	± 3	50 ms	≤ 0.1
10 mS/D	± 3	.1 sec A ONLY	≤ 0.1
20 mS/D	± 3	.2 sec A ONLY	≤ 0.1
50 mS/D	± 3	.5 sec A ONLY	≤ 0.1

TB 9-6625-2346-35

(19) Repeat technique of (14) through (18) above for remaining TI settings and oscilloscope calibrator outputs listed in table 11. If oscilloscope calibrator **Err** display and TI linearity are not within limits specified in table 11, perform **b** (18) through (21) below.

(20) Position TI controls as listed in (a) through (d) below:

- (a) **HORIZONTAL MODE** switch to **B**.
- (b) **A AND B SEC/DIV CAL** knob pushed in.
- (c) **A SEC/DIV** switch to **.1μs**.
- (d) **B SEC/DIV** switch to **.05μs**.

(21) Set oscilloscope calibrator is for a **CHAN 1, MARKER** mode output of 50 ns/div.

(22) Adjust **A** and **B TRIGGER LEVEL**, **B INTENSITY**, and **CH 1 ↕POSITION** controls for suitable viewing.

(23) Adjust TI **←POSITION⇒** control to align 2nd time marker with 2nd vertical graticule line.

(24) Rotate oscilloscope calibrator knob located below **EDIT FIELD** pushbutton to align 10th time marker with 10th vertical graticule line. If oscilloscope calibrator **Err** display and TI linearity are not within limits specified in first row table 12, perform **b** (22) through (24) below.

(25) Repeat technique of (20) (c), (20) (d) and (21) through (24) above for remaining TI settings and oscilloscope calibrator outputs listed in table 12. If oscilloscope calibrator **Err** display and TI linearity are not within limits specified in table 12, perform **b** (22) through (24) below.

Table 12. B Sweep Timing

Oscilloscope calibrator		Test instrument		
MARKER output	Err display limit (%)	A SEC/DIV setting	B SEC/DIV setting	Linearity over any 2 of center 8 divisions (div)
50 nS/D	± 2	.1 μs	.05 μs	≤ 0.1
.1 μS/D	± 2	.2 μs	.1 μs	≤ 0.1
.2 μS/D	± 2	.5 μs	.2 μs	≤ 0.1
.5 μS/D	± 2	1 μs	.5 μs	≤ 0.1
1 μS/D	± 2	2 μs	1 μs	≤ 0.1
2 μS/D	± 2	5 μs	2 μs	≤ 0.1
5 μS/D	± 2	10 μs	5 μs	≤ 0.1
10 μS/D	± 2	20 μs	10 μs	≤ 0.1
20 μS/D	± 2	50 μs	20 μs	≤ 0.1
50 μS/D	± 2	.1 ms	50 μs	≤ 0.1
.1 mS/D	± 2	.2 ms	.1 ms	≤ 0.1
.2 mS/D	± 2	.5 ms	.2 ms	≤ 0.1
.5 mS/D	± 2	1 ms	.5 ms	≤ 0.1
1 mS/D	± 2	2 ms	1 ms	≤ 0.1
2 mS/D	± 2	5 ms	2 ms	≤ 0.1
5 mS/D	± 2	10 ms	5 ms	≤ 0.1
10 mS/D	± 2	20 ms	10 ms	≤ 0.1
20 mS/D	± 2	50 ms	20 ms	≤ 0.1
50 mS/D	± 2	.1 sec A ONLY	50 ms	≤ 0.1

- (26) Pull **TI A AND B SEC/DIV CAL** knob out for X10 sweep magnification.
- (27) Set oscilloscope calibrator for a **CHAN 1, MARKER** mode output of 10 ns/div.
- (28) Set **TI A SEC/DIV** switch to **.05 μs** and **B SEC/DIV** switch to **.1 μs**.
- (29) Adjust **TI A** and **B TRIGGER LEVEL, B INTENSITY,** and **CH 1** **⇕POSITION** controls for suitable viewing.
- (30) Adjust **TI ⇐POSITION⇒** control to align 1st time marker that is 25 ns beyond start of sweep with 2nd vertical graticule line.
- (31) Rotate oscilloscope calibrator knob located below **EDIT FIELD** pushbutton to align 5th time marker with 10th vertical graticule line. If oscilloscope calibrator **Err** display and TI linearity are not within limits specified in table 13, perform **b** (25) through (28) below.

Table 13. B Sweep Timing (X10 out)

Oscilloscope calibrator		Test instrument		
MARKER output	Err display limit (%)	SEC/DIV setting		Linearity over any 2 of center 8 divisions (div)
		A	B	
10 nS/D	± 3	.1 μs	.05 μs	≤ 0.1

- (32) Set **TI A SEC/DIV** switch to **.2 μs** and **B SEC/DIV** switch to **.1 μs**.
- (33) Ensure oscilloscope calibrator is set for a **CHAN 1, MARKER** mode output of 10 ns/div.
- (34) Adjust **TI A** and **B TRIGGER LEVEL, B INTENSITY,** and **CH 1** **⇕POSITION** controls for suitable viewing.
- (35) Adjust **TI ⇐POSITION⇒** control to align 1st time marker that is 25 ns beyond start of sweep with 2nd vertical graticule line.
- (36) Rotate oscilloscope calibrator knob located below **EDIT FIELD** pushbutton to align 10th time marker with 10th vertical graticule line. Oscilloscope calibrator **Err** display and TI linearity will be within limits specified in first row table 14.
- (37) Repeat technique of (32) through (36) above for remaining TI settings and oscilloscope calibrator outputs listed in table 14. Oscilloscope calibrator **Err** display and TI linearity will be within limits specified in table 14.

b. Adjustments

- (1) Position TI controls as listed in (a) through (c) below:
 - (a) **HORIZONTAL MODE** switch to **A**.
 - (b) **A AND B SEC/DIV** switches to **.1 ms**.
 - (c) **X10 CAL** control to in position.
- (2) Set oscilloscope calibrator **MARKER** output to **.1 mS/D**.

Table 14. B Sweep X10 Timing

Oscilloscope calibrator		Test instrument		
MARKER output	Err display limit (%)	SEC/DIV setting		Linearity over any 2 of center 8 divisions (div)
		A	B	
10 nS/D	± 3	.2 μs	.1 μs	≤ 0.1
20 nS/D	± 3	.5 μs	.2 μs	≤ 0.1
50 nS/D	± 3	1 μs	.5 μs	≤ 0.1
.1 μS/D	± 3	2 μs	1 μs	≤ 0.1
.2 μS/D	± 3	5 μs	2 μs	≤ 0.1
.5 μS/D	± 3	10 μs	5 μs	≤ 0.1
1 μS/D	± 3	20 μs	10 μs	≤ 0.1
2 μS/D	± 3	50 μs	20 μs	≤ 0.1
5 μS/D	± 3	.1 ms	50 μs	≤ 0.1
10 μS/D	± 3	.2 ms	.1 ms	≤ 0.1
20 μS/D	± 3	.5 ms	.2 ms	≤ 0.1
50 μS/D	± 3	1 ms	.5 ms	≤ 0.1
.1 mS/D	± 3	2 ms	1 ms	≤ 0.1
.2 mS/D	± 3	5 ms	2 ms	≤ 0.1
.5 mS/D	± 3	10 ms	5 ms	≤ 0.1
1 mS/D	± 3	20 ms	10 ms	≤ 0.1
2 mS/D	± 3	50 ms	20 ms	≤ 0.1
5 mS/D	± 3	.1 sec A ONLY	50 ms	≤ 0.1

- (3) Adjust TI **←POSITION⇒** control to align 1st time marker with 1st (extreme left) vertical graticule line.
- (4) Adjust R740 (fig. 1) for 1 time marker per division over center eight divisions (R).
- (5) Set TI **HORIZONTAL MODE** switch to **B** and adjust **B INTENSITY** control for suitable viewing. Adjust TI **←POSITION⇒** control to align 1st time marker with 1st vertical graticule line.
- (6) Adjust R730 (fig. 1) for 1 time marker per division over center eight divisions (R).
- (7) Set TI **HORIZONTAL MODE** switch to **A** and pull **X10 CAL** control to out position.
- (8) Set oscilloscope calibrator **MARKER** output to **10 μS/D**.
- (9) Adjust TI **←POSITION⇒** control to align nearest time marker to 1st vertical graticule line.
- (10) Adjust R754 (fig. 1) for 1 time marker per division (R).
- (11) Set TI **A AND B SEC/DIV** switches to **.2 ms**.
- (12) Set oscilloscope calibrator **MARKER** output to **1 mS/D**.
- (13) Adjust TI **←POSITION⇒** control to position middle time marker to center vertical graticule line.
- (14) Push TI **X10 CAL** control to in position.

- (15) Adjust R749 (fig. 1) to position middle time marker to center vertical graticule line.
- (16) Pull TI **X10 CAL** control to out position and check that there is no horizontal shift in time marker position.
- (17) Repeat (13) through (16) above until no further improvement is noted.
- (18) Set TI **A AND B SEC/DIV** switches to **.1 μs** and push **X10 CAL** control to in position.
- (19) Set oscilloscope calibrator **MARKER** output to **.1 nS/D**.
- (20) Adjust **A TRIGGER LEVEL** control for a triggered display and **←POSITION⇒** control to align 1st time marker with 1st vertical graticule line.
- (21) Adjust C703 (fig. 1) for 1 time marker per division over center 8 divisions (R).
- (22) Position TI switches as listed in (a) through (c) below:
 - (a) **HORIZONTAL MODE** to **B**.
 - (b) **A SEC/DIV** to **1 μs**.
 - (c) **B SEC/DIV** to **.1 μs**.
- (23) Adjust **←POSITION⇒** control to align 1st time marker with 1st vertical graticule line.
- (24) Adjust C713 (fig. 1) for 1 time marker per division over center 8 divisions (R).
- (25) Position TI controls as listed in (a) through (c) below:
 - (a) **HORIZONTAL MODE** switch to **B**.
 - (b) **A AND B SEC/DIV** switches to **.05 μs**.
 - (c) **X10 CAL** switch to out position.
- (26) Set oscilloscope calibrator **MARKER** output to **10 nS/D**.
- (27) Adjust **←POSITION⇒** control to align 1st time marker that is 25 ns beyond start of sweep with 2nd vertical graticule line.
- (28) Adjust C775 (2236) and C785 (2236) (fig. 1) alternately or C774 only (2236A) (fig. 1) for 1 time marker every 2 divisions over center 8 divisions (R).

10. Triggering

a. Performance Check

- (1) Position TI controls as listed in (a) through (l) below:
 - (a) **VERTICAL MODE CH1 BOTH CH2** switch to **CH 1**.
 - (b) **CH 1** and **CH 2 VOLTS/DIV** switches to **5m**.
 - (c) **A AND B SEC/DIV** switches to **.2 μs**.
 - (d) **B DELAY TIME POSITION** dial fully ccw.
 - (e) **B TRIGGER SLOPE** pushbutton to **OUT**.
 - (f) **B TRIGGER LEVEL** control to midrange.
 - (g) **A TRIGGER P-P AUTO** pushbutton pressed.
 - (h) **A TRIGGER SLOPE** pushbutton to **OUT**.
 - (i) **A TRIGGER LEVEL** control to midrange.
 - (j) **A TRIGGER A&B INT** switch to **VERT MODE**.

TB 9-6625-2346-35

- (k) **A TRIGGER A SOURCE** switch to **INT**.
- (l) **A TRIGGER A EXT COUPLING** switch to **DC**.
- (2) Connect oscilloscope calibrator **SOURCE/MEASURE CHAN 1** to **TI CH 1** input and oscilloscope calibrator **SOURCE/MEASURE CHAN 2** to **TI CH 2** input using **50Ω** feed through terminations.
- (3) Set oscilloscope calibrator for a **SOURCE/MEASURE CHAN 1, LEVEL SINE** output of **10 MHz** and 3.5 divisions of vertical display on **TI**.
- (4) Set **TI CH 1 VOLTS/DIV** switch to **50m**.
- (5) Set **TI A TRIGGER** pushbuttons to combination listed in first row of table 15.
- (6) Adjust **TI A TRIGGER LEVEL** control to obtain a stable display. If a stable display cannot be obtained perform **b** below.
- (7) Repeat technique of (5) and (6) above for remaining **A TRIGGER** pushbutton combinations listed in table 15. If a stable display cannot be obtained perform **b** below.

Table 15. A Trigger Level Channel 1

Test instrument			
A TRIGGER pushbutton combinations		A TRIGGER LEVEL stable display	
MODE	SLOPE	YES	NO
NORM	IN:		
P-P AUTO	IN:		
P-P AUTO	OUT:		

- (8) Set **TI HORIZONTAL MODE A ALT B** switch to **B**. Adjust **B INTENSITY** control for suitable viewing.
- (9) Verify a stable display can be obtained by adjusting **B TRIGGER LEVEL** control in a position other than **B RUNS AFTER DLY**; if not, perform **b** below.
- (10) Press **TI B TRIGGER SLOPE** pushbutton to **IN** and verify a stable display can be obtained by adjusting **B TRIGGER LEVEL** control in a position other than **B RUNS AFTER DLY**; if not, perform **b** below.
- (11) Position controls as listed in (a) through (d) below:
 - (a) **VERTICAL MODE CH1 BOTH CH2** switch to **CH 2**.
 - (b) **HORIZONTAL MODE A ALT B** switch to **A**.
 - (c) **B TRIGGER SLOPE** pushbutton to **OUT**.
 - (d) **A TRIGGER A SOURCE** switch to **CH 2**.

NOTE

Ensure **TI CH 2 VOLTS/DIV** is set to **5m**.

- (12) Set oscilloscope calibrator for a **SOURCE/MEASURE CHAN 2, LEVEL SINE** output of **10 MHz** and 3.5 divisions of vertical display on **TI**.
- (13) Set **TI CH 2 VOLTS/DIV** switch to **50m**.
- (14) Set **TI A TRIGGER** pushbuttons to combination listed in first row of table 16.
- (15) Adjust **TI A TRIGGER LEVEL** control to obtain a stable display. If a stable display cannot be obtained perform **b** below.

Table 16. A Trigger Level Channel 2

Test instrument			
A TRIGGER pushbutton combinations		A TRIGGER LEVEL stable display	
MODE	SLOPE	YES	NO
NORM	IN:		
P-P AUTO	IN:		
P-P AUTO	OUT:		

(16) Repeat technique of (14) and (15) above for remaining **A TRIGGER** pushbutton combinations listed in table 16. If a stable display cannot be obtained perform **b** below.

(17) Set TI **HORIZONTAL MODE A ALT B** switch to **B**. Adjust **B INTENSITY** control for suitable viewing.

(18) Verify a stable display can be obtained by adjusting **B TRIGGER LEVEL** control in a position other than **B RUNS AFTER DLY**; if not, perform **b** below.

(19) Press TI **B TRIGGER SLOPE** pushbutton to **IN** and verify a stable display can be obtained by adjusting **B TRIGGER LEVEL** control in a position other than **B RUNS AFTER DLY**; if not, perform **b** below.

(20) Position controls as listed in (a) through (e) below:

- (a) **VERTICAL MODE CH1 BOTH CH2** switch to **CH 1**.
- (b) **HORIZONTAL MODE A ALT B** switch to **A**.
- (c) **A AND B SEC/DIV** switches to **.1 μs**.
- (d) **B TRIGGER SLOPE** pushbutton to **OUT**.
- (e) **A TRIGGER A&B INT** switch to **VERT MODE**.

(21) Set oscilloscope calibrator for a **SOURCE/MEASURE CHAN 1, LEVEL SINE** output of **60 MHz** and 1.0 divisions of vertical display on TI.

(22) Set TI **A TRIGGER** pushbuttons to combination listed in first row of table 17.

(23) Adjust TI **A TRIGGER LEVEL** control to obtain a stable display. If a stable display cannot be obtained perform **b** below.

(24) Repeat technique of (22) and (23) above for remaining **A TRIGGER** pushbutton combinations listed in table 17. If a stable display cannot be obtained perform **b** below.

Table 17. A Trigger Level Channel 1

Test instrument			
A TRIGGER pushbutton combinations		A TRIGGER LEVEL stable display	
MODE	SLOPE	YES	NO
NORM	IN:		
P-P AUTO	IN:		
P-P AUTO	OUT:		

(25) Set TI **HORIZONTAL MODE A ALT B** switch to **B**. Adjust **B INTENSITY** control for suitable viewing.

(26) Verify a stable display can be obtained by adjusting **B TRIGGER LEVEL** control in a position other than **B RUNS AFTER DLY**; if not, perform **b** below.

TB 9-6625-2346-35

(27) Press TI **B TRIGGER SLOPE** pushbutton to **IN** and verify a stable display can be obtained by adjusting **B TRIGGER LEVEL** control in a position other than **B RUNS AFTER DLY**; if not, perform **b** below.

(28) Position controls as listed in (a) through (c) below:

- (a) **VERTICAL MODE CH1 BOTH CH2** switch to **CH 2**.
- (b) **HORIZONTAL MODE A ALT B** switch to **A**.
- (c) **B TRIGGER SLOPE** pushbutton to **OUT**.

(29) Set oscilloscope calibrator for a **SOURCE/MEASURE CHAN 2, LEVEL SINE** output of **60 MHz** and 1.0 divisions of vertical display on TI.

(30) Set TI **A TRIGGER** pushbuttons to combination listed in first row of table 18.

(31) Adjust TI **A TRIGGER LEVEL** control to obtain a stable display. If a stable display cannot be obtained perform **b** below.

(32) Repeat technique of (30) and (31) above for remaining **A TRIGGER** pushbutton combinations listed in table 18. If a stable display cannot be obtained perform **b** below.

Table 18. A Trigger Level Channel 2

Test instrument			
A TRIGGER pushbutton combinations		A TRIGGER LEVEL stable display	
MODE	SLOPE	YES	NO
NORM	IN:		
P-P AUTO	IN:		
P-P AUTO	OUT:		

(33) Set TI **HORIZONTAL MODE A ALT B** switch to **B**. Adjust **B INTENSITY** control for suitable viewing.

(34) Verify a stable display can be obtained by adjusting **B TRIGGER LEVEL** control in a position other than **B RUNS AFTER DLY**; if not, perform **b** below.

(35) Press TI **B TRIGGER SLOPE** pushbutton to **IN** and verify a stable display can be obtained by adjusting **B TRIGGER LEVEL** control in a position other than **B RUNS AFTER DLY**; if not, perform **b** below.

(36) Position controls as listed in (a) through (d) below:

- (a) **VERTICAL MODE CH1 BOTH CH2** switch to **CH 1**.
- (b) **HORIZONTAL MODE A ALT B** switch to **A**.
- (c) **A AND B SEC/DIV** switches to **.05 μs**.
- (d) **B TRIGGER SLOPE** pushbutton to **OUT**.

(37) Set oscilloscope calibrator for a **SOURCE/MEASURE CHAN 1, LEVEL SINE** output of **100 MHz** and 1.5 divisions of vertical display on TI.

(38) Set TI **A TRIGGER** pushbuttons to combination listed in first row of table 19.

(39) Adjust TI **A TRIGGER LEVEL** control to obtain a stable display. If a stable display cannot be obtained perform **b** below.

(40) Repeat technique of (38) and (39) above for remaining **A TRIGGER** pushbutton combinations listed in table 19. If a stable display cannot be obtained perform **b** below.

Table 19. A Trigger Level Channel 1

Test instrument			
A TRIGGER pushbutton combinations		A TRIGGER LEVEL stable display	
MODE	SLOPE	YES	NO
NORM	IN:		
P-P AUTO	IN:		
P-P AUTO	OUT:		

(41) Set TI **HORIZONTAL MODE A ALT B** switch to **B**. Adjust **B INTENSITY** control for suitable viewing.

(42) Verify a stable display can be obtained by adjusting **B TRIGGER LEVEL** control in a position other than **B RUNS AFTER DLY**; if not, perform **b** below.

(43) Press TI **B TRIGGER SLOPE** pushbutton to **IN** and verify a stable display can be obtained by adjusting **B TRIGGER LEVEL** control in a position other than **B RUNS AFTER DLY**; if not, perform **b** below.

(44) Position controls as listed in (a) through (c) below:

- (a) **VERTICAL MODE CH1 BOTH CH2** switch to **CH 2**.
- (b) **HORIZONTAL MODE A ALT B** switch to **A**.
- (c) **B TRIGGER SLOPE** pushbutton to **OUT**.

(45) Set oscilloscope calibrator for a **SOURCE/MEASURE CHAN 2, LEVEL SINE** output of **100 MHz** and 1.5 divisions of vertical display on TI.

(46) Set TI **A TRIGGER** pushbuttons to combination listed in first row of table 20.

(47) Adjust TI **A TRIGGER LEVEL** control to obtain a stable display. If a stable display cannot be obtained perform **b** below.

(48) Repeat technique of (46) and (47) above for remaining **A TRIGGER** pushbutton combinations listed in table 20. If a stable display cannot be obtained perform **b** below.

Table 20. A Trigger Level Channel 2

Test instrument			
A TRIGGER pushbutton combinations		A TRIGGER LEVEL stable display	
MODE	SLOPE	YES	NO
NORM	IN:		
P-P AUTO	IN:		
P-P AUTO	OUT:		

(49) Set TI **HORIZONTAL MODE A ALT B** switch to **B**. Adjust **B INTENSITY** control for suitable viewing.

(50) Verify a stable display can be obtained by adjusting **B TRIGGER LEVEL** control in a position other than **B RUNS AFTER DLY**; if not, perform **b** below.

(51) Press TI **B TRIGGER SLOPE** pushbutton to **IN** and verify a stable display can be obtained by adjusting **B TRIGGER LEVEL** control in a position other than **B RUNS AFTER DLY**; if not, perform **b** below.

TB 9-6625-2346-35

(52) Position controls as listed in (a) through (d) below:

- (a) **VERTICAL MODE CH1 BOTH CH2** switch to **CH 1**.
- (b) **HORIZONTAL MODE A ALT B** switch to **A**.
- (c) **A TRIGGER NORM** pushbutton pressed.
- (d) **A TRIGGER A SOURCE** switch to **EXT**.

(53) Connect oscilloscope calibrator **SOURCE/MEASURE CHAN 1** to **TI EXT INPUT** using a 50Ω feed through termination.

(54) Set oscilloscope calibrator for a **SOURCE/MEASURE CHAN 1, LEVEL SINE** output of **10 MHz** at an amplitude of 35 mV.

(55) Set **TI A TRIGGER** pushbuttons to combination listed in first row of table 21.

(56) Press in and hold **TI TRIG VIEW** pushbutton while adjusting **A TRIGGER LEVEL** control to obtain a stable display.

(57) Repeat technique of (55) and (56) above for remaining **A TRIGGER** pushbutton combinations listed in table 21.

Table 21. A Trigger Level A Source to Ext Input

Test instrument			
A TRIGGER pushbutton combinations		A TRIGGER LEVEL with TRIG VIEW in stable display	
MODE	SLOPE	YES	NO
NORM	IN:		
P-P AUTO	IN:		
P-P AUTO	OUT:		

(58) Release **TRIG VIEW** pushbutton.

(59) Set oscilloscope calibrator for a **SOURCE/MEASURE CHAN 1, LEVEL SINE** output of **60 MHz** at an amplitude of 120 mV.

(60) Pull **X10 CAL** control to out position and set **TI A TRIGGER** pushbuttons to combination listed in first row of table 22.

(61) Press in and hold **TI TRIG VIEW** pushbutton while adjusting **A TRIGGER LEVEL** control to obtain a stable display.

(62) Repeat technique of (60) and (61) above for remaining **A TRIGGER** pushbutton combinations listed in table 22.

Table 22. A Trigger Level A Source to Ext Input

Test instrument			
A TRIGGER pushbutton combinations		A TRIGGER LEVEL with TRIG VIEW in stable display	
MODE	SLOPE	YES	NO
NORM	IN:		
P-P AUTO	IN:		
P-P AUTO	OUT:		

(63) Release **TRIG VIEW** pushbutton.

(64) Set oscilloscope calibrator for a **SOURCE/MEASURE CHAN 1, LEVEL SINE** output of **100 MHz** at an amplitude of 150 mV.

(65) Set TI **A TRIGGER** pushbuttons to combination listed in first row of table 23.

(66) Press in and hold TI **TRIG VIEW** pushbutton while adjusting **A TRIGGER LEVEL** control to obtain a stable display.

(67) Repeat technique of (60) and (61) above for remaining **A TRIGGER** pushbutton combinations listed in table 23.



Table 23. A Trigger Level A Source to Ext Input

Test instrument			
A TRIGGER pushbutton combinations		A TRIGGER LEVEL with TRIG VIEW in stable display	
MODE	SLOPE	YES	NO
NORM	IN:		
P-P AUTO	IN:		
P-P AUTO	OUT:		

b. Adjustments

NOTE

For adjustment of model 2236, perform steps (1) through (27) below. For adjustment of model 2236A, perform only steps (10) through (27) below.

- (1) Disconnect equipment setup.
- (2) Position TI controls as listed in (a) through (m) below:
 - (a) All **POSITION** controls to midrange.
 - (b) **VERTICAL MODE CH 1 BOTH CH 2** switch to **BOTH**.
 - (c) **VERTICAL MODE ADD ALT CHOP** switch to **ALT**.
 - (d) **CH 1** and **CH 2 VOLTS/DIV** switches to **.5**.
 - (e) **CH 1** and **CH 2 AC GND DC** switches to **GND**.
 - (f) **HORIZONTAL MODE A ALT B** switch to **A**.
 - (g) **A AND B SEC/DIV** switches to **1 ms**.
 - (h) **B TRIGGER SLOPE** to **OUT:** .
 - (i) **B TRIGGER LEVEL** to midrange.
 - (j) **A TRIGGER P-P AUTO** pushbutton pressed.
 - (k) **A TRIGGER SLOPE** pushbutton to **OUT:** .
 - (l) **A TRIGGER LEVEL** to midrange.
 - (m) **A TRIGGER A&B INT** switch to **CH 2**.
- (3) Adjust TI **CH 1** and **CH 2** **POSITION** controls to set both traces to the center horizontal graticule line.
- (4) Connect digital multimeter **LO** to chassis ground and **HI** to TP460 (fig. 1). Digital multimeter indication will be less than 80 mV dc. Record digital multimeter indication.
- (5) Set TI **A TRIGGER A&B INT** switch to **CH 1**.

TB 9-6625-2346-35

- (6) Adjust R309 (fig. 1) for digital multimeter indication recorded in (4) above.
- (7) Set TI **A TRIGGER A&B INT** switch to **CH 2**.
- (8) Repeat (4) through (7) above until digital multimeter indications in (4) and (6) are within ± 1 mV dc.
- (9) Disconnect digital multimeter.
- (10) Position TI switches as listed in (a) through (e) below:
 - (a) **VERTICAL MODE CH 1 BOTH CH2** to **CH 1**.
 - (b) **CH 1 VOLTS/DIV** to **.1**.
 - (c) **CH 1** and **CH 2 AC GND DC** to **AC**.
 - (d) **A AND B SEC/DIV** to **10 μ s**.
 - (e) **A TRIGGER A&B INT** to **CH 1**.
- (11) Connect oscilloscope calibrator **SOURCE/MEASURE CHAN 1** to TI **CH 1** using 50 Ω feed through termination.
- (12) Set oscilloscope calibrator for a **SOURCE/MEASURE CHAN 1, LEVEL SINE** output of **50 kHz** and 2.2 divisions of vertical display on TI.
- (13) Set TI **CH 1 VOLTS/DIV** switch to **1**.
- (14) Adjust R471 (2236) (fig. 2) or R479 (2236A) (fig. 2) while rotating **A TRIGGER LEVEL** control slowly so that **A TRIGGER** is just able to be maintained (R).

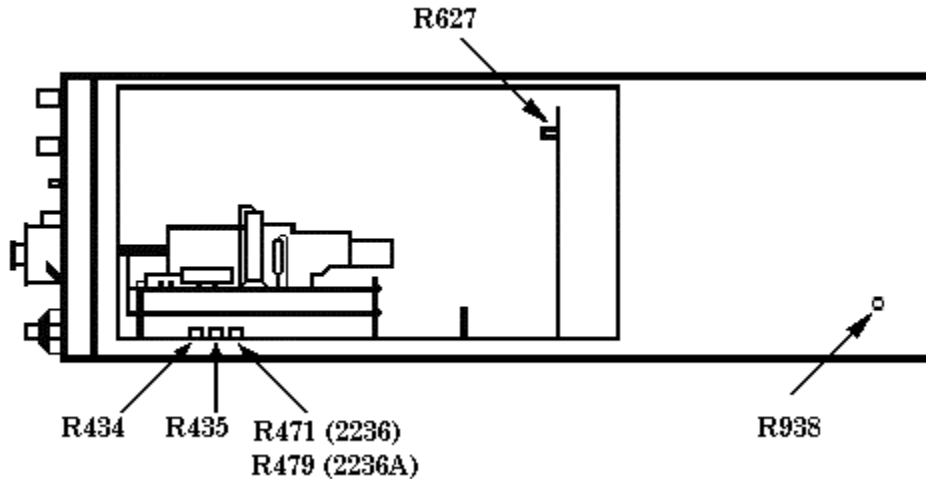





Figure 2. Adjustments – right side view.

- (15) Set TI **CH 1 VOLTS/DIV** switch to **50m** and adjust **A TRIGGER LEVEL** control fully cw.
- (16) Set oscilloscope calibrator **LEVEL SINE** output amplitude for 5 divisions of vertical display on TI.
- (17) Set TI **CH 1 VOLTS/DIV** switch to **.5**.
- (18) Adjust R434 (fig. 2) so display just solidly triggers on positive peak of signal (R).

- (19) Press **TI A TRIGGER SLOPE** pushbutton to **IN:**  and adjust **A TRIGGER LEVEL** control fully ccw.
- (20) Adjust R435 (fig. 2) so display just solidly triggers on negative peak of signal (R).
- (21) Connect oscilloscope calibrator **SOURCE/MEASURE CHAN 1** to one side of a BNC tee. Connect BNC tee to **TI CH 1** using a X10 attenuator and 50Ω feedthrough termination. Connect remaining side of BNC tee to **TI EXT INPUT**.
- (22) Set **TI CH 1 VOLTS/DIV** switch to **10m** and **A TRIGGER A SOURCE** switch to **EXT**.
- (23) Set oscilloscope calibrator for a **LEVEL SINE** output of **50 kHz** and 2.2 divisions of vertical display on TI.
- (24) Adjust **TI A TRIGGER LEVEL** control for a stable display.
- (25) Set **TI HORIZONTAL MODE A ALT B** switch to **B** and adjust **B TRIGGER LEVEL** control for a stable display.
- (26) Set **TI CH 1 VOLTS/DIV** switch to **.1**.
- (27) Adjust R627 (fig. 2) so that a display can be maintained by adjusting **B TRIGGER LEVEL** control (R).

11. Counter Timer Multimeter

a. Performance Check

- (1) Position TI controls as listed in (a) through (o) below:
- (a) **CH 1** \updownarrow **POSITION** to midrange.
 - (b) **VERTICAL MODE CH1 BOTH CH 2** switch to **CH 1**.
 - (c) **CH 1 VOLTS/DIV** switch to **.5**.
 - (d) **CH 1 AC GND DC** switch to **DC**.
 - (e) \Leftarrow **POSITION** \Rightarrow to midrange.
 - (f) **HORIZONTAL MODE A ALT B** switch to **A**.
 - (g) **A SEC/DIV** switch to **.5 μs**.
 - (h) **B SEC/DIV** switch to **.05 μs**.
 - (i) **B TRIGGER SLOPE** pushbutton to **OUT:** .
 - (j) **B TRIGGER LEVEL** control to midrange.
 - (k) **VAR HOLDOFF** to **NORM**.
 - (l) **A TRIGGER P-P AUTO** pushbutton pressed.
 - (m) **A TRIGGER SLOPE** pushbutton to **OUT:** .
 - (n) **A TRIGGER LEVEL** control to midrange.
 - (o) **A&B INT** switch to **CH 1**.
- (2) Connect time frequency generator **J6** output (rear panel) to **TI CH 1** input.
- (3) Set time frequency for a 1 MHz output.
- (4) Press **TI UPPER FUNCTIONS IN LOWER FUNCTIONS OUT** pushbutton to the **IN** position.
- (5) Press **TI FREQ** pushbutton.

TB 9-6625-2346-35

- (6) TI readout should indicate between 999.9900 kHz and 1.000010 MHz (999.9995 kHz and 1.000000 MHz for option 14). If not, perform b (1) through (9) below.
- (7) Press TI **PER** pushbutton.
- (8) TI readout will indicate between .99800 μ s and 1.00200 μ s.
- (9) Disconnect equipment setup.
- (10) Press TI **DCV** pushbutton.
- (11) Connect a short between TI **MULTIMETER INPUTS**.
- (12) TI readout will indicate between $-$.0001 and .0001 V, if not, perform **b** (10) through (17) below.
- (13) Remove short from TI **MULTIMETER INPUTS**.
- (14) Connect calibrator **OUTPUT** terminals to TI **MULTIMETER INPUTS**.
- (15) Set calibrator for a DC output of 400 mV. If TI readout indication is not within limits specified in first row of table 24, perform **b** (18) through (23) below.
- (16) Repeat technique of (15) above for calibrator outputs listed in table 24. If TI readout indication is not within limits specified in table 24, perform **b** (18) through (23) below.

Table 24. Multimeter DC Volts

Calibrator output	Test instrument indication limits	
	Min	Max
400 mV	.3995	.4005
$-$ 400 mV	$-$.3995	$-$.4005
4.0 V	3.995	4.005
$-$ 4.0 V	$-$ 3.995	$-$ 4.005
40 V	39.95	40.05
$-$ 40 V	$-$ 39.95	$-$ 40.05
400 V	399.5	400.5
$-$ 400 V	$-$ 399.5	$-$ 400.5

- (17) Reduce calibrator output to minimum and disconnect equipment setup.
- (18) Press TI **UPPER FUNCTIONS IN LOWER FUNCTIONS OUT** pushbutton to the **OUT** position.
- (19) Press TI **AC RMSV** pushbutton.
- (20) Connect a short between TI **MULTIMETER INPUTS**.
- (21) TI readout will indicate $<$.0006 V, if not, perform **b** (24) through (29) below.
- (22) Remove short from TI **MULTIMETER INPUTS**.
- (23) Connect calibrator **OUTPUT** terminals to TI **MULTIMETER INPUTS**.
- (24) Set calibrator for an output of 400 mV at 20 Hz. If TI readout indication is not within limits specified in first row of table 25, perform **b** (30) through (39) below.

Table 25. Multimeter AC Volts

Calibrator output		Test instrument indication limits	
Voltage	Frequency	Min	Max
400 mV	20 Hz	.3954	.4046
400 mV	400 Hz	.3954	.4046
400 mV	1 kHz	.3954	.4046
400 mV	10 kHz	.3954	.4046
400 mV	20 kHz	.3954	.4046
4.0 V	20 Hz	3.954	4.046
4.0 V	20 kHz	3.954	4.046
40.0 V	20 Hz	39.54	40.46
40.0 V	20 kHz	39.54	40.46
300 V	20 Hz	296.4	303.6
300 V	20 kHz	296.4	303.6

(25) Repeat technique of (24) above for calibrator outputs listed in table 25. If TI readout indication is not within limits specified in table 25, perform **b** (30) through (39) below.

(26) Reduce calibrator output to minimum and disconnect equipment setup.

(27) Press TI **UPPER FUNCTIONS IN LOWER FUNCTIONS OUT** pushbutton to the **IN** position.

(28) Press TI Ω /  pushbutton.

(29) Connect a short between TI **MULTIMETER INPUTS**.

(30) TI readout will indicate $< .20 \Omega$.

(31) Remove short from TI **MULTIMETER INPUTS**.

(32) Connect calibrator **OUTPUT** terminals to TI **MULTIMETER INPUTS**.

NOTE

Use calibrator **2 WIRE COMP** for checks through 10 k Ω .

(33) Set calibrator for a 10 Ω nominal output.

(34) Rotate calibrator output adjustment knob located below **AMPL/FREQ** pushbutton until calibrator display is equal to TI indication. Calibrator **Err** displayed will be within limits specified in first row of table 26.

(35) Repeat technique of (33) and (34) above for calibrator outputs listed in table 26. Calibrator **Err** displayed will be within limits specified in table 26.

Table 26. Multimeter Ohms

Calibrator	
Nominal output (Ω)	Error display limits \pm (%)
10	2.3
100	.4
1 k	.4
10 k	.4
100 k ¹	.4
1 M	.4
10 M	.4
100 M	1.1

¹Set calibrator **2-WIRE COMP** to **OFF**

- (36) Disconnect equipment setup.
- (37) Position TI controls as listed in (a) through (d) below:
 - (a) **UPPER FUNCTIONS IN LOWER FUNCTIONS OUT** pushbutton to the **OUT** position.
 - (b) **CH 1 V** pushbutton pressed.
 - (c) **CH 1 VOLTS/DIV** switch to **50m**.
 - (d) **CH 1 AC GND DC** switch to **GND**.
- (38) TI readout will indicate between $-.0012$ and $.0012$, if not, perform **b** (40) and (41) below.
- (39) Set TI **AC GND DC** switch to **DC**.
- (40) Connect calibrator **OUTPUT** to TI **CH 1 or X & DMM** input.
- (41) Set calibrator for an output of 400 mV. If TI readout indication is not within limits specified in first row of table 27, perform **b** (42) through (48) below.
- (42) Repeat technique of (37) (c) and (41) above for calibrator outputs and TI switch settings listed in table 27. If TI readout indication is not within limits specified in table 27, perform **b** (42) through (48) below.

Table 27. CH 1 DC Volts

Calibrator Output (DC Volts)	VOLTS/DIV	Test instrument	
		Indication limits	
		Min	Max
400 mV	50 m	.3982	.4018
4.0 V	0.5	3.982	4.018
40 V	5	39.82	40.18

- (43) Set calibrator output to minimum.
- (44) Set TI **AC GND DC** switch to **AC**.
- (45) Set TI **CH 1 VOLTS/DIV** switch to **50m**.
- (46) Set calibrator for an output of 400 mV at a frequency of 20 kHz. If TI readout indication is not within limits specified in first row of table 28, perform **b** (49) through (54) below.

(47) Repeat technique of (45) and (46) above for calibrator outputs and TI switch settings listed in table 28. If TI readout indication is not within limits specified in table 28, perform **b** (49) through (54) below.

Table 28. CH 1 AC Volts

Calibrator output		Test instrument		
Voltage	Frequency	VOLTS/DIV	Min	Max
400 mV	20 kHz	50 m	.3954	.4046
4.0 V	20 kHz	0.5	3.954	4.046
40 V	20 kHz	5	39.54	40.46

(48) Set all outputs to minimum and disconnect equipment setup.

b. Adjustments

- (1) Set all outputs to minimum and disconnect equipment setup.
- (2) Press TI **UPPER FUNCTIONS IN LOWER FUNCTIONS OUT** pushbutton to the **IN** position.
- (3) Press TI **PER** pushbutton.
- (4) Connect time frequency generator **J6** output (rear panel) to TI **CH 1** input.
- (5) Set time frequency for a 1 MHz output.
- (6) Adjust C1311 (2236/2236A) (fig. 3) or TCXO CAL (Option 14) (fig. 3) for a TI indication of 1.00000 μ s.

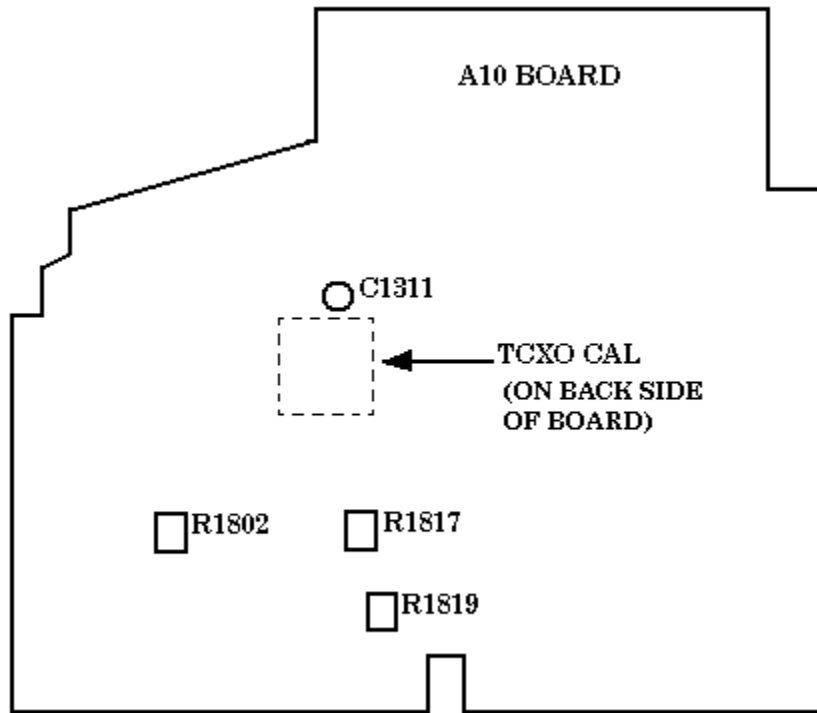

Figure 3. CTM adjustment locations.

TB 9-6625-2346-35

- (7) Press TI **FREQ** pushbutton.
- (8) Adjust C1311 (2236/2236A) (fig. 3) for a TI indication between 999.9991 kHz and 999.9999 kHz or adjust TCXO CAL (Option 14) (fig. 3) for a TI indication of 1.000000 MHz.
- (9) Disconnect time frequency generator **J6** output (rear panel) from TI **CH 1** input.
- (10) Set TI **HORIZONTAL MODE A ALT B** switch to **A**.
- (11) Press TI **DCV** pushbutton.
- (12) Rotate R1819 (fig. 3) to fully ccw position.
- (13) Connect a short between TI **MULTIMETER INPUTS**.
- (14) Adjust R1817 (fig. 3) for a TI indication of .0000 V.
- (15) Remove short from TI **MULTIMETER INPUTS**.
- (16) Adjust R1819 (fig. 3) for a TI indication of .0000 V.
- (17) Repeat technique of (13) through (16) above until no further improvement is noticed.
- (18) Connect calibrator **OUTPUT** terminals to TI **MULTIMETER INPUTS**.
- (19) Set calibrator for a DC output of 400 mV.
- (20) Adjust R1919 (fig 4) for a TI indication of .4000 V (R).
- (21) Set calibrator for a DC output of -400 mV.
- (22) Check TI reading is between -.3999 and -.4001.
- (23) Set calibrator output to minimum.
- (24) Press TI **UPPER FUNCTIONS IN LOWER FUNCTIONS OUT** pushbutton to the **OUT** position.
- (25) Press TI **AC RMSV** pushbutton.
- (26) Rotate R1908 (fig. 4) to fully cw position.
- (27) Connect a short between TI **MULTIMETER INPUTS**.
- (28) Adjust R1908 (fig. 4) until TI last digit is 0 and does not toggle between 0 and 1.
- (29) Remove short from TI **MULTIMETER INPUTS**.
- (30) Connect calibrator **OUTPUT** terminals to TI **MULTIMETER INPUTS**.
- (31) Set calibrator for an output of 400 mV at a frequency of 1 kHz.
- (32) Adjust R1904 (fig. 4) for a TI indication of .4000 V (R).
- (33) Change calibrator output amplitude to 4.0 V.
- (34) Adjust R1967 (fig. 4) for a TI indication of 3.997 V (R).
- (35) Change calibrator output amplitude to 40 V.
- (36) Adjust R1966 (fig. 4) for a TI indication of 39.97 V (R).
- (37) Change calibrator output amplitude to 300 V.
- (38) Adjust R1965 (fig. 4) for a TI indication of 299.8 V (R).
- (39) Set calibrator output to minimum and disconnect equipment setup.

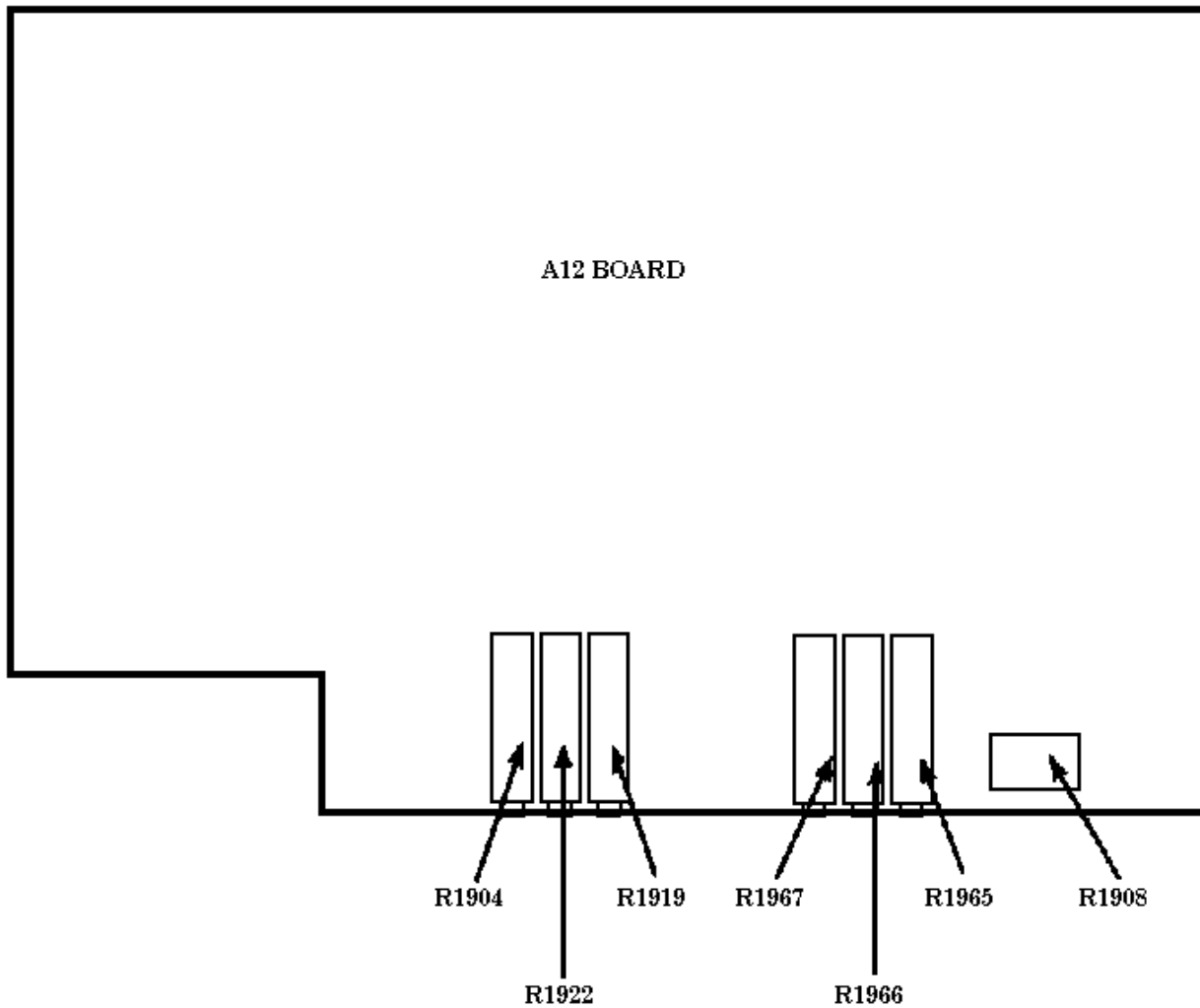

Figure 4. A12 board adjustment locations.



- (40) Position TI controls as listed in (a) through (d) below:
- (a) **UPPER FUNCTIONS IN LOWER FUNCTIONS OUT** pushbutton to the **OUT** position.
 - (b) **CH 1 V** pushbutton pressed.
 - (c) **CH 1 VOLTS/DIV** switch to **50 m**.
 - (d) **CH 1 AC GND DC** switch to **GND**.
- (41) Adjust R1802 (fig. 3) for a TI indication of .0000 V.
- (42) Set TI **CH 1 AC GND DC** switch to **DC**.
- (43) While holding in TI **P-P AUTO** pushbutton, push TI **SGL SWP** pushbutton.
- (44) Connect calibrator **OUTPUT** to TI **CH 1 or X & DMM** input.
- (45) Set calibrator for an output of 400 mV.
- (46) Adjust R1922 (fig. 4) for a TI indication of .4000 V (R).

TB 9-6625-2346-35

- (47) Press TI **SGL SWP** pushbutton.
- (48) Set calibrator output to minimum.
- (49) Position TI controls as listed in (a) and (b) below:
 - (a) **CH 1 AC GND DC** switch to **AC**.
 - (b) **A TRIGGER P-P AUTO** pressed.
- (50) Set calibrator for an output of 400 mV at a frequency of 20 kHz.
- (51) Adjust C3 (fig. 1) for a TI indication of .4000 V (R).
- (52) Set TI **CH 1 VOLTS/DIV** switch to **.5**.
- (53) Change calibrator output amplitude to 4 V.
- (54) Adjust C12 (L) (fig. 1) for a TI indication of 4.000 V (R).

12. Probe Adjust

a. Performance Check

- (1) Connect TI **PROBE ADJUST** (2236) or **CAL**  (2236A) to TI **CH 1** input.
- (2) Set TI **CH 1 VOLTS/DIV** switch and variable control for 5 divisions of vertical display (do not change setting).
- (3) Disconnect TI **PROBE ADJUST** (2236) or **CAL**  (2236A) from TI **CH 1** input.
- (4) Connect oscilloscope calibrator **SOURCE/MEASURE CHAN 1** to TI **CH 1** input.
- (5) Set oscilloscope calibrator for an output of 500 mV at 1 kHz.
- (6) Adjust TI **A TRIGGER LEVEL** and **POSITION** controls, as necessary, to view waveform.
- (7) Rotate oscilloscope calibrator knob located below **EDIT FIELD** key for 5 divisions of vertical display.
- (8) Oscilloscope calibrator **err** display will indicate within $\pm 5\%$.
- (9) Reduce outputs to minimum and disconnect equipment setup.
- (10) If necessary, rotate TI **CH 1 VOLTS/DIV CAL** fully cw to detent.

b. Adjustments None

13. Power Supply

NOTE

Do not perform power supply check if all other parameters are within tolerance.

a. Performance Check. Connect digital multimeter to TI TP961 (-8.6) (fig. 1) and chassis ground. If digital multimeter does not indicate between -8.56 and -8.60 V dc, perform **b** below.

b. Adjustments. Adjust R938 (fig. 2) for a digital multimeter indication of -8.60 V dc (R).

14. Final Procedure

- a.** Deenergize and disconnect all equipment.
- b.** Annotate and affix label/form in accordance with TB 750-25.

By Order of the Secretary of the Army:

Official:



JOEL B. HUDSON

*Administrative Assistant to the
Secretary of the Army*

0319504

JOHN M. KEANE
*General, United States Army
Acting Chief of Staff*

Distribution:

To be distributed in accordance with IDN 344786, requirements for calibration procedure TB 9-6625-2346-35.

THESE ARE THE INSTRUCTIONS FOR SENDING AN ELECTRONIC 2028

The following format must be used if submitting an electronic 2028. The subject line must be exactly the same and all fields must be included; however, only the following fields are mandatory: 1, 3, 4, 5, 6, 7, 8, 9, 10, 13, 15, 16, 17, and 27.

From: "Whomever" whomever@avma27.army.mil

To: 2028@redstone.army.mil

Subject: DA Form 2028

1. **From:** Joe Smith
2. **Unit:** Home
3. **Address:** 4300 Park
4. **City:** Hometown
5. **St:** MO
6. **Zip:** 77777
7. **Date Sent:** 19-Oct-93
8. **Pub No:** TB 9-6625-xxxx-35
9. **Pub Title:** Calibration Procedure for ...
10. **Publication Date:**
11. **Change Number:**
12. **Submitted Rank:** MSG
13. **Submitter Fname:** Joe
14. **Submitter Mname:** T
15. **Submitter Lname:** Smith
16. **Submitter Phone:** (123) 123-1234
17. **Problem:** 1
18. **Page:** 2
19. **Paragraph:** 3
20. **Line:** 4
21. **NSN:** 5
22. **Reference:** 6
23. **Figure:** 7
24. **Table:** 8
25. **Item:** 9
26. **Total:** 123
27. **Text:**

This is the text for the problem below line 27.

